

Technical Memorandum

Date: October 2, 2015 Project Number: 1870.04

To: Wally Pereyra, Ph.D.

From: Daniel P. Turner, P.E.

Project: Zaccuse Creek Sammamish Parkway Culvert

Subject: Project Planning Document

1. Introduction

This Technical Memorandum (TM) was prepared for and funded by Dr. Wally Pereyra to assist in his efforts with the Lake Sammamish Kokanee Workgroup (Kokanee Workgroup) to move forward the restoration of habitat for Kokanee Salmon in Zaccuse Creek. The purpose of this TM is to provide Dr. Pereyra with a conceptual design for replacement of the Lake Sammamish Parkway (Parkway) culvert. It includes a recommended layout of the culvert to meet state and federal fish passage, storm drainage, and roadway needs, a list of the permits most likely needed for the project, an estimated overall cost of the project, an estimated project implementation schedule, and a list of possible funding sources available. Drawings for this TM can be found in Attachment A. This TM is a follow-on task from two previous TMs completed by R2 for Dr. Pereyra that provided the primary basis for the conceptual design for the Parkway culvert. A preliminary design for the Zaccuse Creek restoration upstream of the culvert was completed in development of the R2 2012 Technical Memorandum (R2 2012) and a Planning Study (R2 2015) outlined steps for implementation.

Zaccuse Creek has been identified as a Category 3 stream by the Kokanee Workgroup in the “Blueprint for the Restoration and Enhancement of Sammamish Kokanee Tributaries” (LSKWG 2014). The Kokanee Workgroup recommended Zaccuse Creek as a stream important to establishing a self-sustaining population of native fish in Lake Sammamish, and recommended 3 culverts located downstream of the Pereyra property for replacement (Drawing 1). The Parkway culvert is owned by the City of Sammamish (City), is the furthest upstream, and is the largest of the three culverts. The other two culverts are owned by King County and are scheduled for replacement with the future modifications to the Sammamish River Trail.

2. Parkway Culvert Conceptual Design

Design data used for development of the R2 2012 TM is directly applicable to the Parkway culvert site. The creek restoration design in the R2 2012 TM relied on a reconnaissance topographic survey of the site conducted by R2. The conceptual design developed for this TM also relies on the 2012 topographic survey which provides adequate detail for determination of quantities of materials for use as the basis of a preliminary cost estimate for the Parkway culvert replacement. The topographic survey included a profile of the creek alignment in 2012 through the site and the three culverts, including the horizontal location of the creek and other pertinent elevations. A more detailed survey would be needed for the final design phase of the project. Other information collected at the site included bank full reference widths, pebble counts, and a culvert barrier assessment.

The R2 2012 TM determined that the culvert reach is a continuation of the stream restoration through the Pereyra property necessary not only for fish passage, but also for establishment of a stable stream channel and improved spawning possibilities throughout the entire lower portion of the creek. Based on field data and following the WDFW stream simulation design process, a design profile, creek bed, and recommended creek and culvert dimensions were determined in the R2 20102 TM. This information is shown in this TM on the Plan and Profile found on Drawing 1 in Attachment A.

The current creek alignment upstream of the existing culvert appears to be affected primarily by the deposition of material at the entrance to the existing 36-inch diameter concrete Parkway culvert. R2's conclusion based on observation and analysis is that the existing Parkway culvert does not have the capacity to pass high flows without causing a backwater effect upstream. The backwater condition results in lower creek velocities upstream and subsequent gravel deposition. Currently, the creek is aligned flowing west of the culvert intersecting the Parkway roadway embankment approximately 120 feet southwest of the culvert entrance, then flowing parallel to the roadway embankment to the culvert entrance.

A 10 ft wide by 57 ft long precast concrete, bottomless box culvert was recommended for the Parkway in the R2 TM (2012). This culvert would be similar to the box culvert recently placed nearby in Ebright Creek. An enlarged plan view of a conceptual layout with section views is shown Drawing 2. The total height of the culvert from the top to the base of the footings would be 7.66-ft, and the clear height from the bottom of the lid to the creek bed along the walls would be 6-ft. Approximately 3.0-ft of gravel culvert streambed mix would be placed within the

culvert resulting in a 10-ft wide by 3-ft deep opening for Zaccuse Creek. The location of utilities (sewer, water, power, cable, and telephone) shown on the drawings is approximate, and the accurate location of utilities, the right of way, easements, and additional topographic information would be determined during the early stage of the final design phase of the project.

The stream profile is designed to a constant 3.45 percent slope through the Pereyra property and the three culverts (R2 2012). This constant slope design is intended to eliminate the fish passage barriers caused by the perched entrance condition of the existing culverts, while also minimizing the potential for gravel deposition at the entrance. Given the gravel and sediment size sampled in 2012, this gradient is intended to allow for transport of the bedload through the three culverts. The width of the creek through the new culvert is based on the observed bank flow width of observed reference reaches upstream. This design should conservatively pass any flood flows in Zaccuse creek without the backwater effect at the culvert entrance that currently exists. We are assuming that the material excavated will be acceptable for most of the backfill for the new culvert. The exception would be for select structural fill used for a narrow band of material placed adjacent to the concrete culvert.

This TM does not include a traffic routing study that would consider methods of diverting traffic around the construction of the culvert. There is a 60-ft wide right of way through the site, which we are assuming would be wide enough to allow phased construction of the culvert, and would also allow for one-way traffic through the site during construction hours. A formal study of options for control of traffic would be conducted by the City as part of their planning and design for the project. Traffic control has been accounted for in the cost estimate.

3. Project Permitting

The City would be required to apply for permits for the Parkway culvert project as any other entity would be required. This would include federal, state, and local permits. This permit process would fall under the Joint Aquatic Resource Permit Application (JARPA) process that is followed for water resource projects in the State of Washington. A State Environmental Policy Act (SEPA) condition checklist would also be included as part of the JARPA. The result of the SEPA checklist would determine whether more work would be required for the JARPA. The list below includes the probable permits that would be necessary for the project. R2 did not conduct any formal consultation with permitting agencies for this TM, and recommends initiating consultation to confirm and refine this list.

Joint Aquatic Resource Permit Applications (JARPAs) for Federal and State Permits

U.S. Army Corps of Engineers (USACE) Section 10/404 Permit and Nationwide Permits
Section 7 ESA Consultation with NMFS and USFWS
Ecology Section 401 Water Quality Certification
WDFW Hydraulic Project Approvals, and Exemptions for Fish and Wildlife Enhancement Project
WDNR Aquatic Use Authorization
Ecology Coastal Zone Management (CZM) Consistency Determination
WDNR Aquatic Land Leases and Aquatic Land Use Authorizations

Other State Permits

NPDES Construction Stormwater General Permit

Shoreline Permit Applications

Shoreline Substantial Developments
Shoreline Conditional Uses (for which Ecology is the final decision maker)
Shoreline Exemption – most likely under Fish Habitat Enhancement Projects (RCW 90.58.147 and RCW 77.55.181)

City Permits

Building Permit
Right-of-way Use Permit
Construction Permit
Utility Permit

Local Forms, Applications and Reports

SEPA/NEPA Compliance, SEPA Checklist
Critical Areas Review and Mitigation Plans
Clearing and Grading Permits
Flood Hazard Prevention and Floodplain Development Permits, and
FEMA No-Net-Rise Certification for Floodways

Tribal Usual and Accustomed Fishing Areas

Coordination with Tribes related to review of SEPA/NEPA documents, permit applications, and mitigation plans

4. Opinion of Probable Cost

A total project cost was developed based on quantity estimates based on the conceptual design, recent published cost data based on similar sized and types of projects, and R2 cost estimation experience. Unit costs were taken primarily from similar (WSDOT 2015) and King County Roads (Kameda 2015) bid tabulations from similar projects. The WSDOT Coe-Clemons culvert project crosses SR203 near the City of Duvall, and is similar to the Parkway Culvert project. Unit costs for excavation and backfill materials, and traffic mitigation were proportioned based on project size. A construction cost contingency of 30 percent was applied to the subtotal construction cost. Other cost contingencies for design/project management and construction management were applied at 30 percent each. Final costs for permitting and utility coordination were estimated as lump sum costs. R2's total estimated Opinion of Probable Cost is estimated to be \$844,000 in 2015 dollars. At the time of this TM's publication, the ENR CCI was 10398 for Seattle. A reasonable escalation of this amount to future dates can be determined by multiplying the ratio of the current ENR CCI by this 2015 CCI, by the total amount. A breakdown of the materials, quantities, and unit price estimates are shown in Table 1 below.

Table 1. Sammamish Parkway Culvert Replacement, Estimated Opinion of Probable Cost.

DESCRIPTION	QUANTITY	UNIT	UNIT PRICE	TOTAL
General				\$ 58,000
Mobilization	1	LS	\$ 50,000	\$ 50,000
Clearing and Grubbing	0.1	Acre	\$ 10,000	\$ 1,000
Fish Rescue	1	LS	\$ 1,500	\$ 1,500
Gravel Analysis	1	LS	\$ 500	\$ 500
Construction Survey	1	LS	\$ 5,000	\$ 5,000
Demolition				\$ 14,000
Sawcut asphalt	100	LF	\$ 50	\$ 5,000
Demolition of roadway asphalt and existing 36" concrete culvert	1,500	SF	\$ 6	\$ 9,000
Pre-cast Concrete Box Culvert				\$ 96,000
Bottomless Box Delivered (10 FT SPAN, 57 FT LONG)	57	LF	\$ 1,000	\$ 57,000
Footings	1	LS	\$ 15,000	\$ 15,000
Culvert Installation and Joint Grouting	1	LS	\$ 15,000	\$ 15,000
Subgrade Preparation	360	SF	\$ 25	\$ 9,000
Earthwork and Roadway				\$ 161,780
Cut	700	CY	\$ 20	\$ 14,000
Structural Fill	400	CY	\$ 50	\$ 20,000
Design Gravel Mixing	100	CY	\$ 75	\$ 7,500
Crushed Gravel Base	53	CY	\$ 30	\$ 1,590
Hot Mix Asphalt	33	TON	\$ 130	\$ 4,290
Beam Guard Rail Type 1	110	LF	\$ 40	\$ 4,400
Erosion Control and Planting	1	LS	\$ 5,000.00	\$ 5,000
Temporary Stream Diversion & Dewatering	1	LS	\$ 30,000.00	\$ 30,000
Project Traffic Control	1	LS	\$ 75,000.00	\$ 75,000
Site Restoration and Planting				\$ 15,000
Planting/Watering	1	LS	\$ 10,000	\$ 10,000
Site Restoration	1	LS	\$ 5,000	\$ 5,000
SUBTOTAL (ROUNDED)				\$ 344,780
CONSTRUCTION CONTINGENCY	30%			\$ 103,430
TOTAL CONSTRUCTION COST				\$ 448,000
CITY ADMIN, DESIGN, AND PM	40%			\$ 179,200
CONSTRUCTION AND CONTRACT MANAGEMENT	35%			\$ 156,800
PERMITTING				\$ 50,000
UTILITY COORDINATION				\$ 10,000
TOTAL DESIGN AND CONSTRUCTION				\$ 844,000
R2 Disclaimer - The client acknowledges that R2 has no control over costs of labor, materials, competitive bidding environments and procedures, unidentified field conditions, financial and/or market conditions, or any other factors likely to affect the Opinion of Probable Construction Cost (OPCC) of this project, all of which are and will unavoidably remain in a state of change, especially in light of the high volatility of the market beyond the control of the parties. Client further acknowledges that this OPCC is a "snapshot in time" and that the reliability of this OPCC will degrade over time. Client agrees that R2 cannot and does not make any warranty, promise, guarantee or representation, either express or implied, that proposals, bids, project construction costs, or cost of O&M functions will not vary significantly from R2 good faith OPCC.				

5. Preliminary Schedule for Project Development

A Gantt chart project schedule is shown as Figure 1 that was developed by R2 independently of City input for this TM. Project timelines are based on R2 staff experience on similar projects, with the goal to provide a realistic amount of design and review time, with project construction occurring as soon as possible in the summer of 2017. The critical path timeline follows completing the project design through the 60% phase, then following a one year period for the permitting process prior to starting construction within the HPA permit in water work period. In our experience, allowing for a one year permitting time period is common for water related projects, and the 60% design is normally adequate to prepare permitting documents. Completion of the final design would also be required prior to bidding. We are assuming that the City will not proceed with the project construction bidding process until all the pertinent permits are issued. The construction in-water work period would likely be similar to the Ebright culvert replacement project, which was mid-July through late September, and would be sufficient for this project.

While there is time to meet 2017 construction goal, it would be best to start the design and permitting process very soon. We recommend commencing design within a month as shown. Assuming funding is available and the City could proceed quickly with a design effort, over a year would be available to secure the funding necessary for construction.

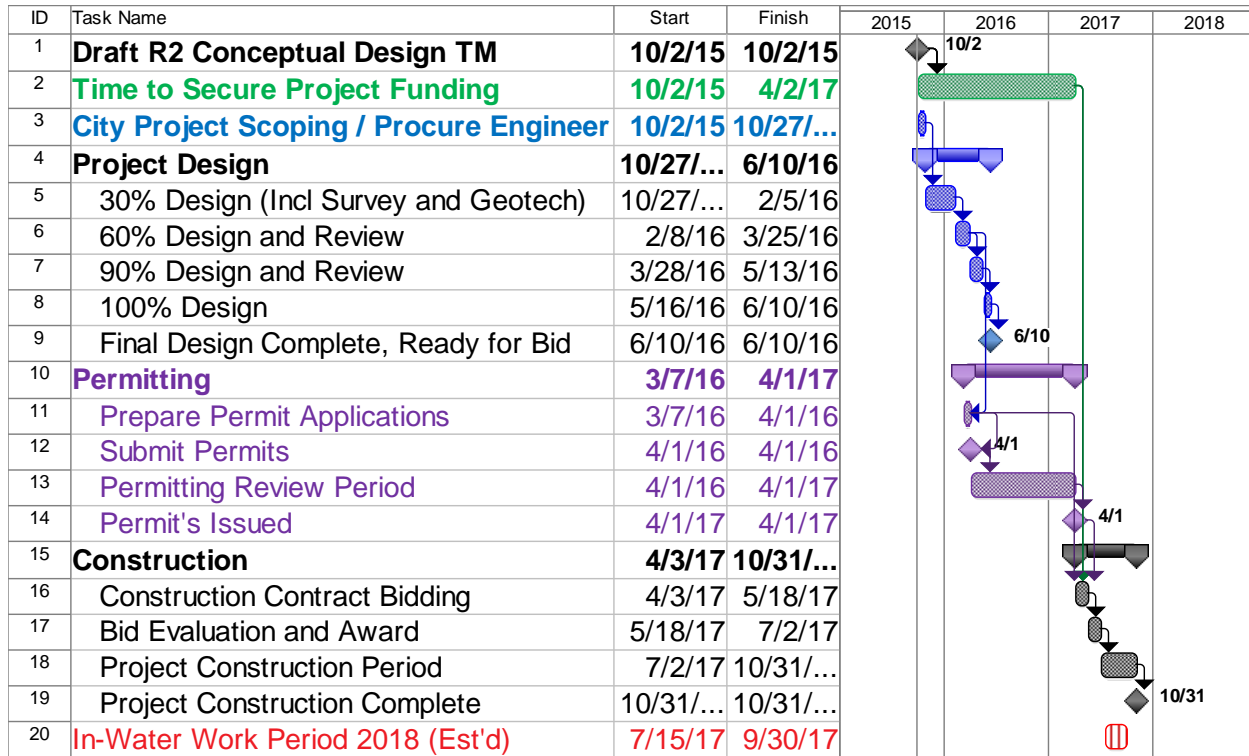

Figure 1. Zaccuse Creek Sammamish Parkway Culvert Replacement Schedule.

6. Project Funding Sources

The City owns the roadway and culvert; therefore, we assume they would fund and manage the implementation of the entire project. Several funding sources may be available to offset the cost to the City. Table 2 includes a list of possible funding sources that the City may choose to utilize for the Parkway Project, which was developed with input from David Steiner from the Snoqualmie Tribe. There may be other funding sources and opportunities identified with further investigation.

Table 2. Possible Project Funding Sources.

Title of Funding Source	Funding Entity	Timeframe	Types of Projects Covered	Requirements
Salmon Recovery Funding	Washington State Recreation and Conservation Office (RCO)	August Annually	Salmon habitat improvement projects.	15%, no limit, except for design only projects which are limited to \$200,000
King County Conservation District	Member Jurisdiction Funding	Annually, Feb - Oct	Direct Improvement of Natural Resources Conditions	
Bring Back the Natives/More Fish http://www.nfwf.org/bbn/Pages/home.aspx	NFWF	Annually July - August	Restore Native Fish Populations	1:1 match
Five Star & Urban Waters Restoration Program	NFWF	Annually November through February	Priority Species and habitat restoration	1:1 Match or >, Grant awards range from \$20 – 50k
WRIA 8 Cooperative Watershed Management Grant Program http://govlink.org/watersheds/8/funding/default.aspx#cwm	King County Flood Control District	Jan - Apr	Priority salmon habitat projects, monitoring, outreach & education	No match requirement
National Fish Passage Program http://www.fws.gov/fisheries/whatwedo/NFPP/nfpp.html	U.S. Fish and Wildlife Service	Annually	Fish Passage Improvements	50% Federal or Non-Federal Cash or In-Kind Match
Tribal Wildlife Grant Program http://www.fws.gov/nativeamerican/grants.html	U.S. Fish and Wildlife Service	Annually, May through Oct	Priority Fish & Wildlife Projects incl. Habitat & Monitoring	Up to \$200,000. No match required. Local Federally Recognized Tribe Snoqualmie/Muckleshoot must sponsor/apply.
Tribal Implementation Funding Grant Program	EPA/Puget Sound Partnership	Annually, Aug - Sep	Priority salmon habitat improvement projects	Varies: Avg. \$112,000 per FY. Local Tribe (Snoqualmie or Muckleshoot) must sponsor/apply)

7. Summary

This TM was developed for and funded by Dr. Wally Pereyra to assist with his advocacy for full restoration of Zaccuse creek, specifically to identify design, schedule, and funding needs for replacement of the Sammamish Parkway culvert. This document was prepared solely by R2, with limited consultation with other stakeholders, owners, or regulators. The design concept was developed to meet current local, state, and federal regulations and guidelines, and will provide a reasonable basis for further investigations and to pursue project funding. R2 would be happy to address any questions and assist with project implementation upon request.

8. Literature Cited and Reviewed

David Evans and Associates, Inc. 2012. Ebright Creek Enhancement Project. Prepared for the City of Sammamish. Sammamish, WA.

Kameda, Wes. King County Department of Natural Resources, Water and Lands Division. August 25, 2015. Personal communication, e-mail to Dan Turner (R2 Resource Consultants, Inc.) regarding recent cost data for King County box culvert projects.

LSKWG (Lake Sammamish Kokanee Work Group). 2014. Blueprint for the Enhancement of Lake Sammamish Kokanee Tributaries. King County, WA.

Parametrix. 2010. Draft Thompson Basin Plan. Prepared for the City of Sammamish. Bellevue, WA.

R2 (R2 Resource Consultants, Inc.). 2012. Technical Memorandum. Zaccuse Creek: To Provide Design Guidance for Culvert Replacement Projects and Possible Realignment and Re-grading of Zaccuse Creek Upstream of the Culvert Replacement Projects. 23 pages. Redmond, WA.

R2 (R2 Resource Consultants, Inc.). 2015. Technical Memorandum. Zaccuse Creek Restoration: Initial Study Plan. 23 pages. Redmond, WA.

WDFW (Washington Department of Fish and Wildlife). 2009. Fish Passage and Surface Water Diversion Screening Assessment and Prioritization Manual. Olympia, WA.

WDFW (Washington Department of Fish and Wildlife). 2013. Water Crossing Design Guidelines. Olympia, WA.

WSDOT (Washington State Department of Transportation). 2015. WSDOT Bid Tabulations. Retrieved from <http://www.wsdot.wa.gov/biz/contaa/BIDTAB/JAN/JAN2015/14A009.PDF>

Attachment A

Drawings

FILED IN: \\NAS\Shared Projects\1870 Perryo Fish\Zaccuse Creek\Drawings\1870 Zaccuse Creek - Sam Culvert.dwg
 DRAWN: Sam Culvert.dwg
 CHECKED: Dan Turner
 PLOTTED: Dan Turner 9/30/2015 1:17 PM
 PLOTTED: Dan Turner 9/30/2015 1:21 PM

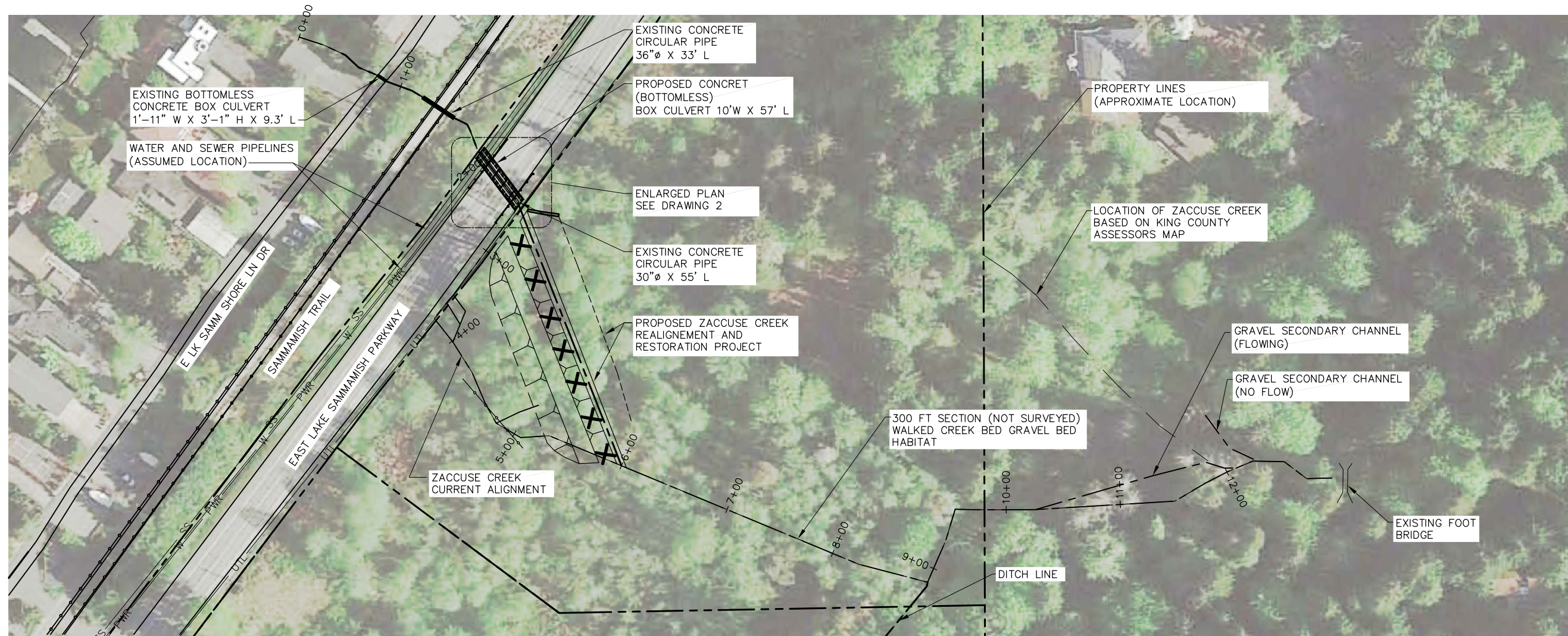

- NOTES:
1. SURVEY APRIL 13TH, 2012. VERTICAL DATUM ASSUMED
 2. SEE R2 TECHNICAL MEMORANDUM DATED JUNE 18, 2012 FOR ADDITIONAL INFORMATION

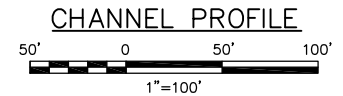
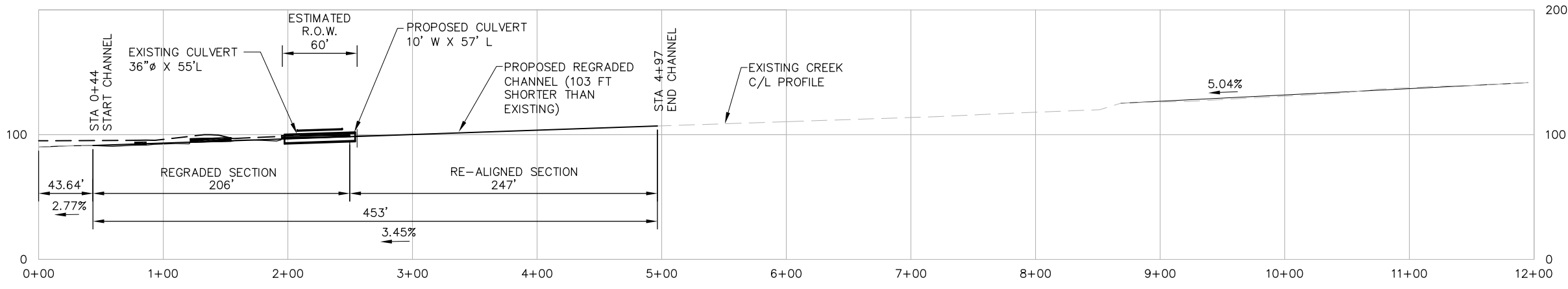
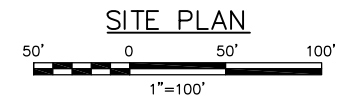

DRAFT

Resource Consultants, Inc.
 REDMOND, WA.

ZACCUSE CREEK
 SAMMAMISH PARKWAY CULVERT
 CONCEPTUAL DESIGN – DRAWING 1
 PLAN AND PROFILE

09/30/15

FILED IN: \\NAS\Shared Projects\1870 Perryo Fish\Zaccuse Creek Culverts\2015_Sammamish Parkway Culvert\Drawings\1870 Zaccuse Creek - Ssm Culvert.dwg
 DRAWN: Dan Turner
 CHECKED: Dan Turner
 PLOTTED: Dan Turner 9/30/2015 1:17 PM
 PLOTTED: Dan Turner 9/30/2015 1:26 PM

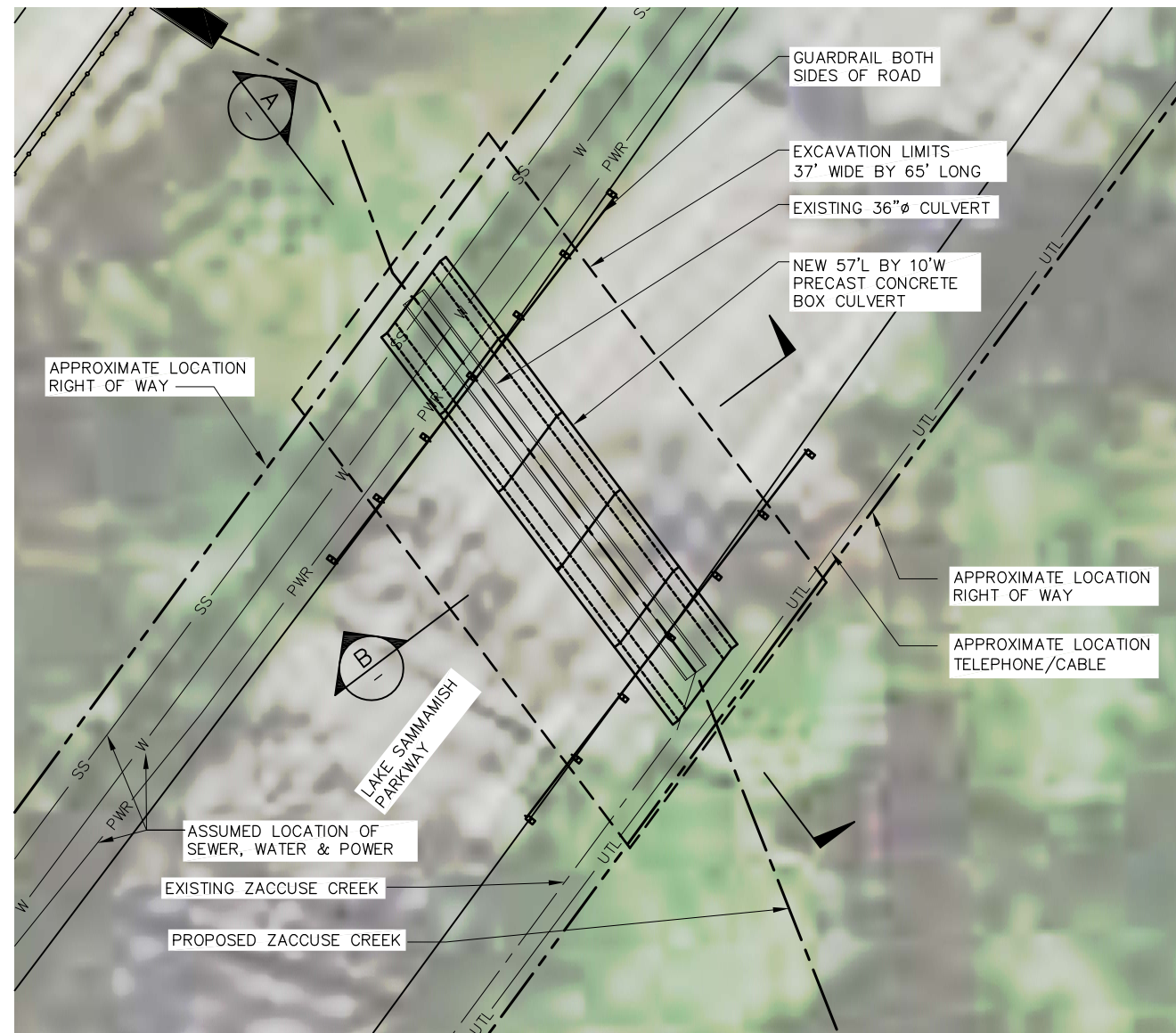

CULVERT PLAN

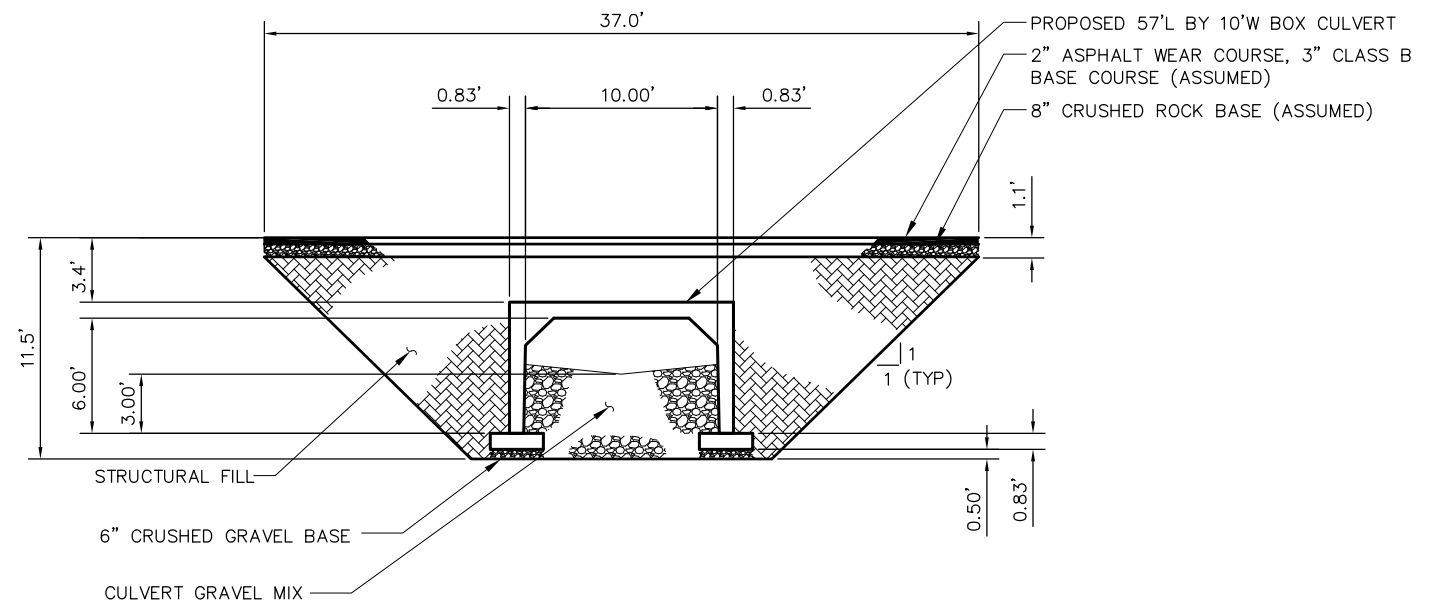
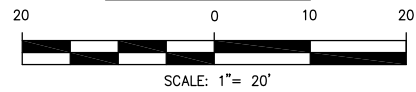

SECTION
 PERPENDICULAR SECTION
 THROUGH CULVERT

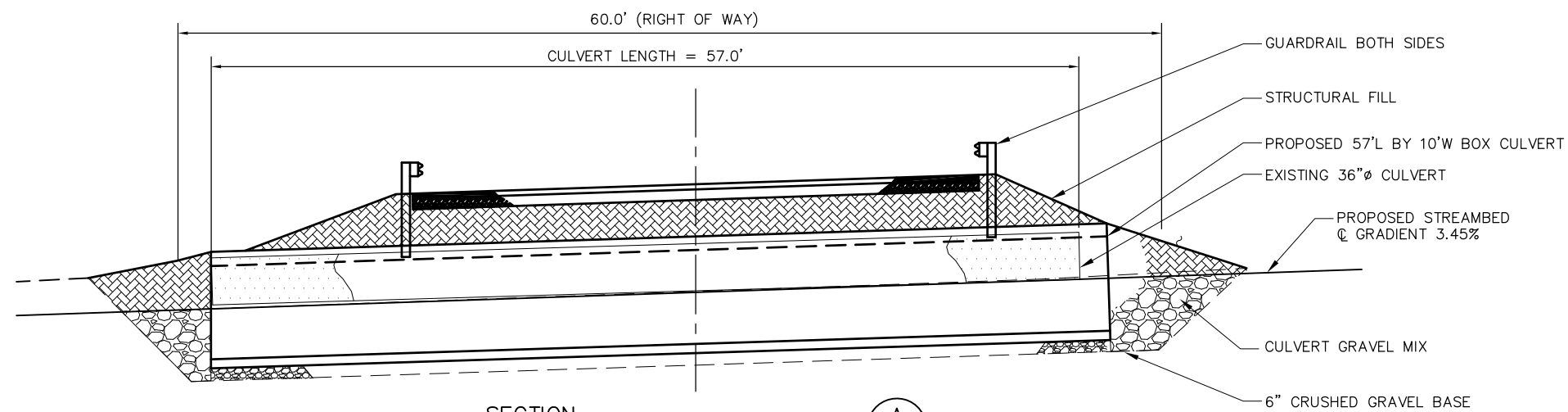
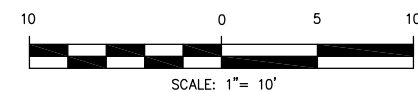

SECTION
 SECTION THROUGH CULVERT

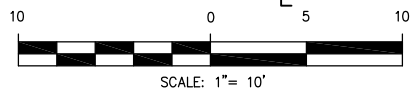

DRAFT

Resource
 Consultants, Inc.
 REDMOND, WA.

ZACCUSE CREEK
 SAMMAMISH PARKWAY CULVERT
 CONCEPTUAL DESIGN - DRAWING 2
 SITE PLAN AND SECTIONS

09/30/15